

X-Large

XL 5401

Istruzioni di montaggio

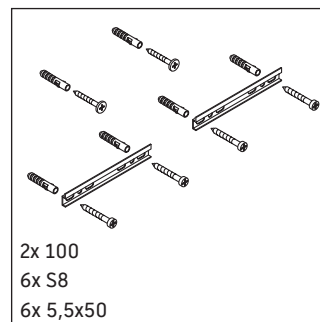
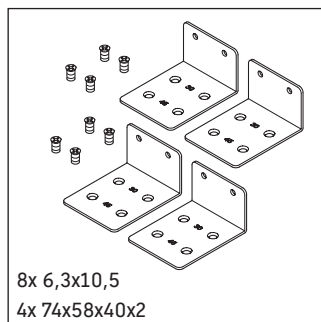
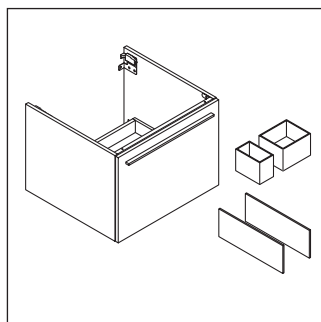
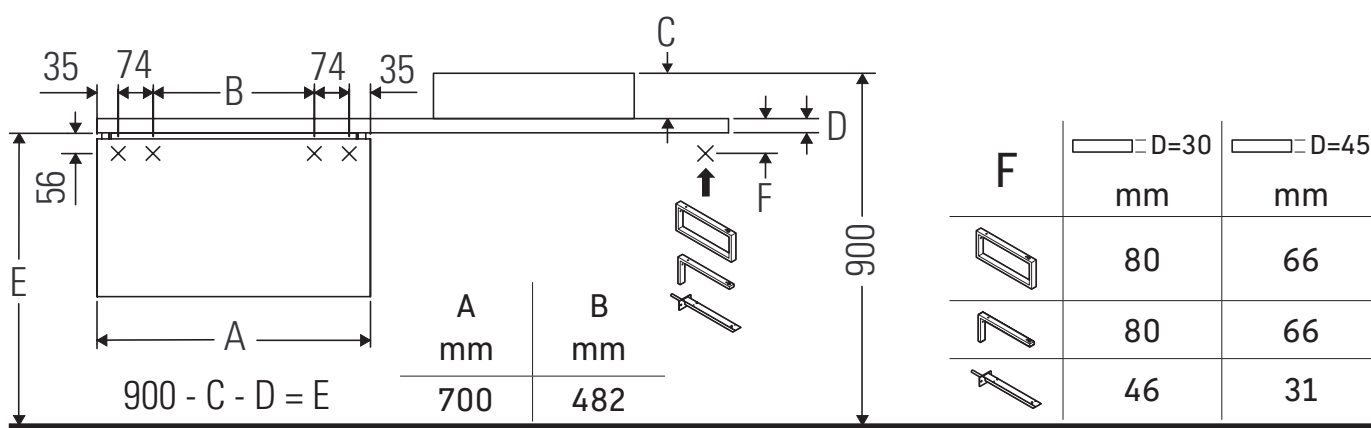

Rispettare le quote di foratura.



Rispettare tutte le ulteriori istruzioni di montaggio.

Avvertenze per l'utilizzo

La serie di mobili da bagno è conforme alle norme e direttive vigenti al momento della consegna ed è pensata per l'impiego nei bagni. Evitare di bagnare direttamente con acqua, ad esempio facendo la doccia.

Le ceramiche più larghe di 600 mm devono essere fissate alla parete.

Con riserva di apportare modifiche tecniche ai prodotti illustrati.

