

L-Cube

LC 7653

Istruzioni di montaggio

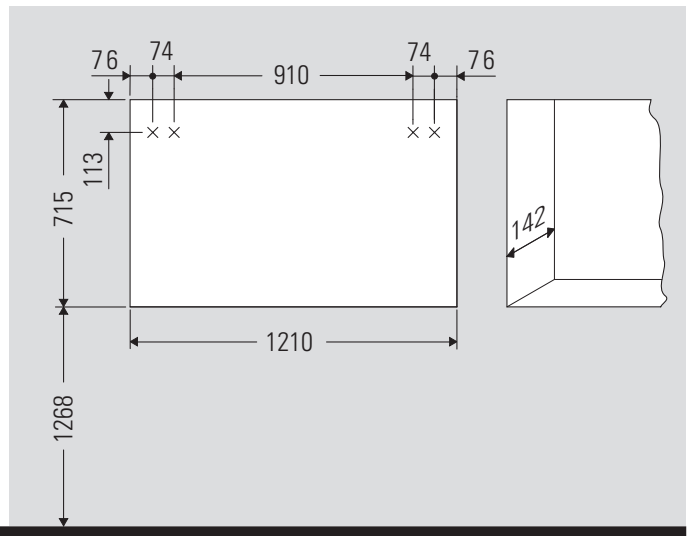
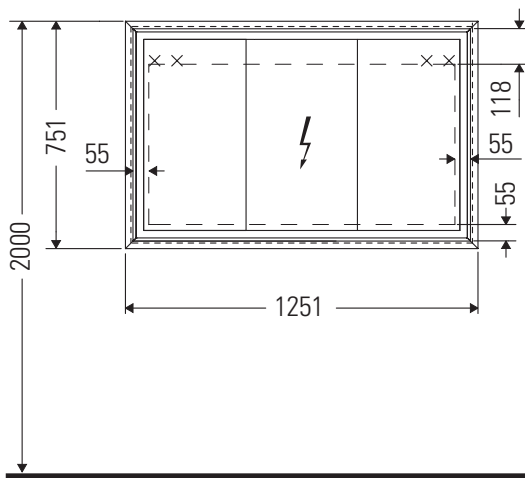

Dimensioni dell'apertura per armadi da incasso

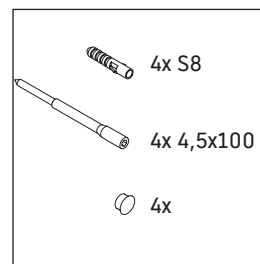
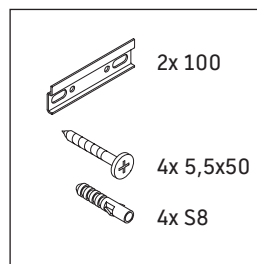
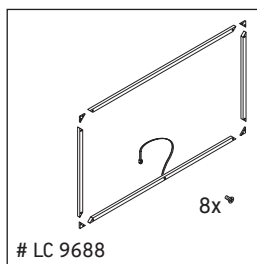
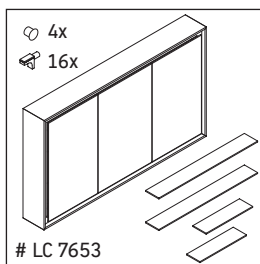

Seguire le istruzioni di montaggio per mobili da bagno con passaggio di corrente elettrica.

Avvertenze per l'utilizzo

La serie di mobili da bagno è conforme alle norme e direttive vigenti al momento della consegna ed è pensata per l'impiego nei bagni. Evitare di bagnare direttamente con acqua, ad esempio facendo la doccia.

L'allacciamento elettrico a 110 V - 230 V deve essere predisposto in loco.

Con riserva di apportare modifiche tecniche ai prodotti illustrati.



LC 9688

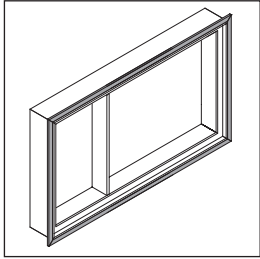

1 # LC 9688

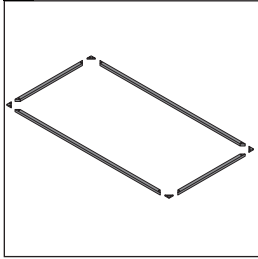

2 # LC 9688

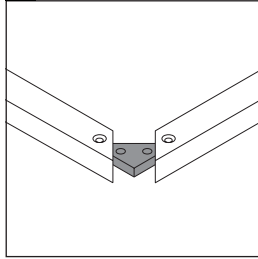

3 # LC 9688

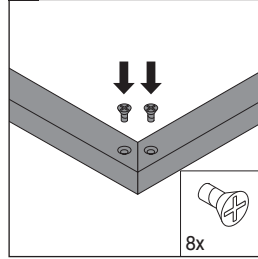

4

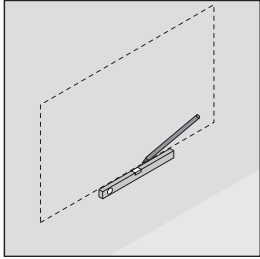

5

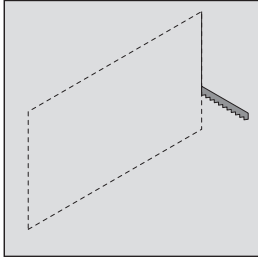

6

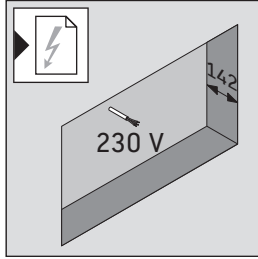

7

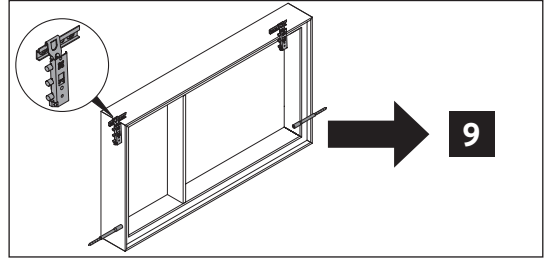

8

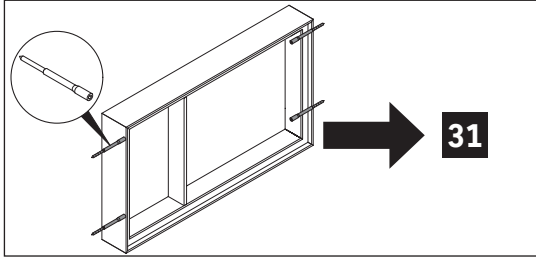

9

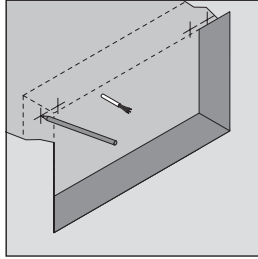

10

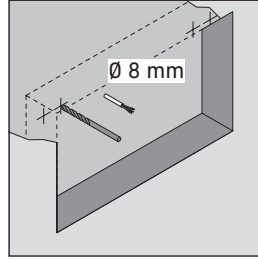

11

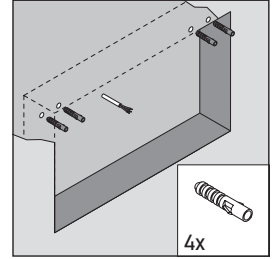

12

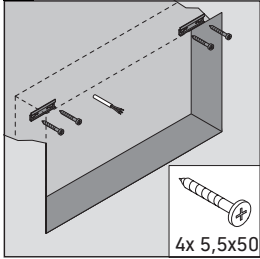

13

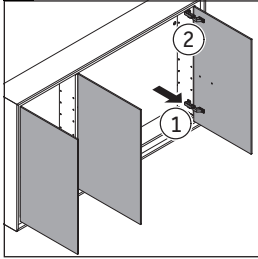

14

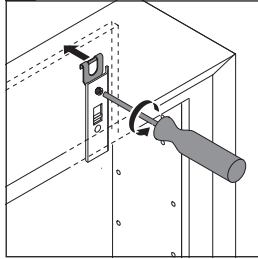

15

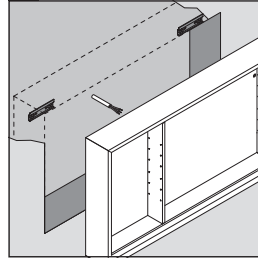

16

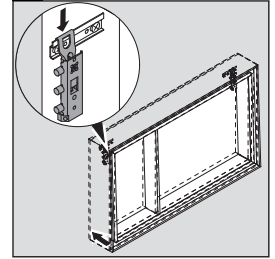

17

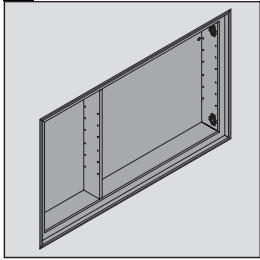

18

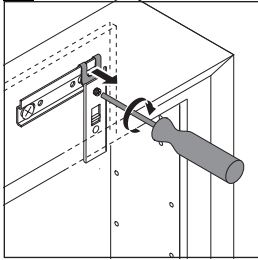

19

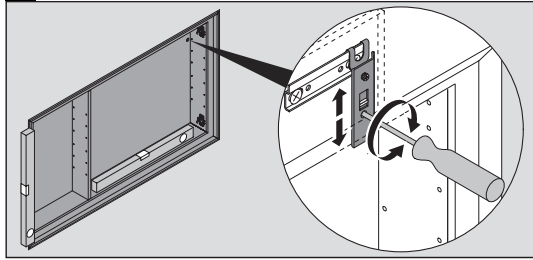

20

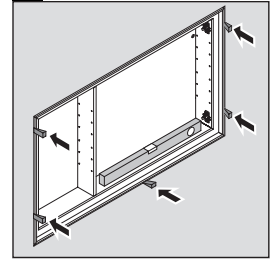

21

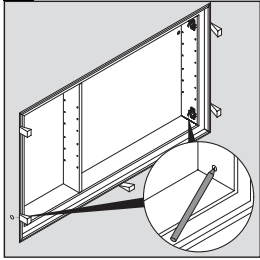

22

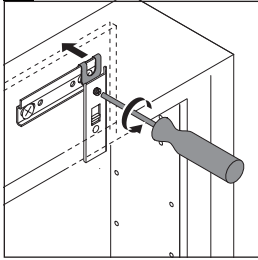

23

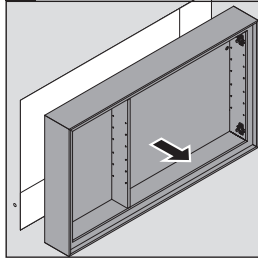

24

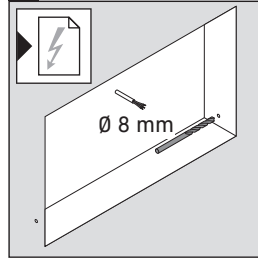

25

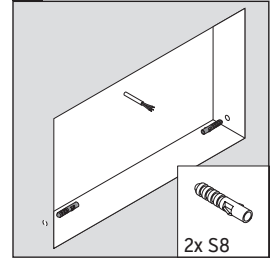

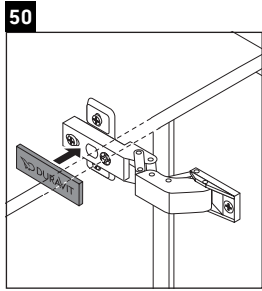
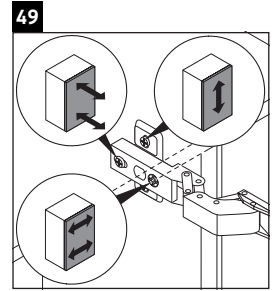
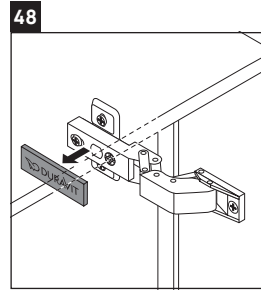
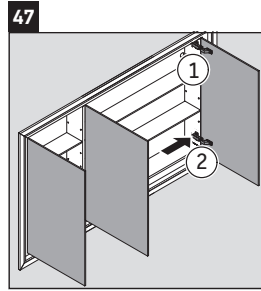
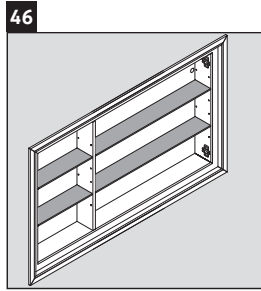
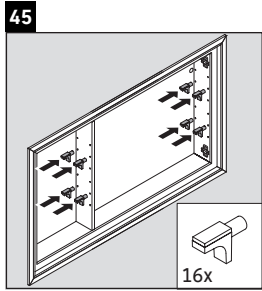
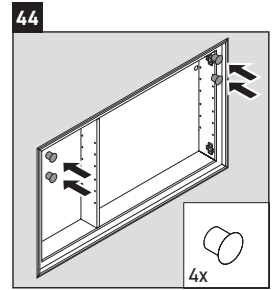
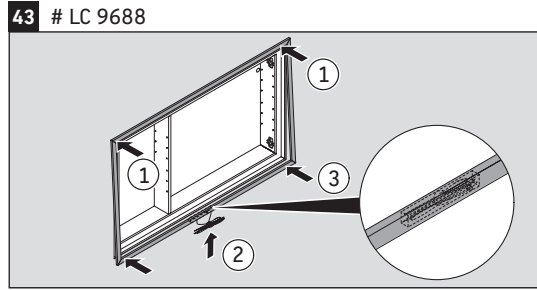
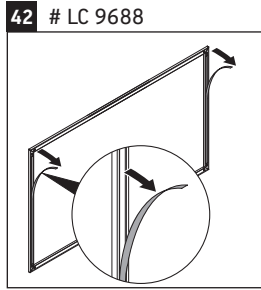
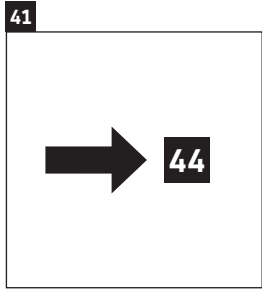
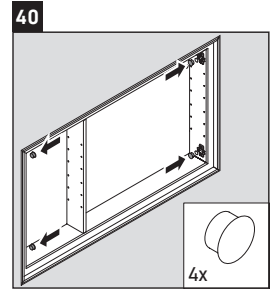
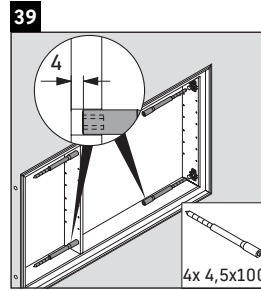
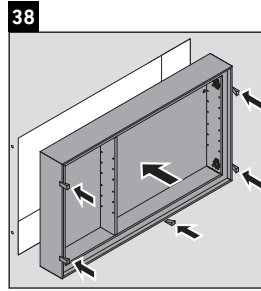
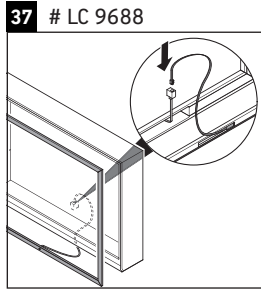
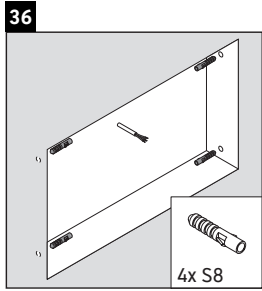
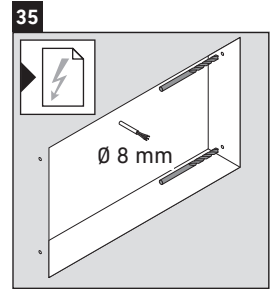
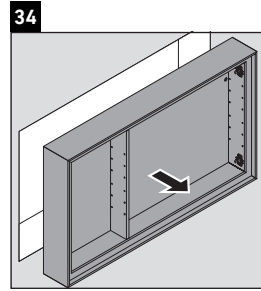
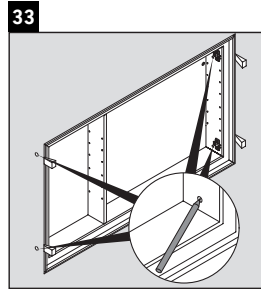
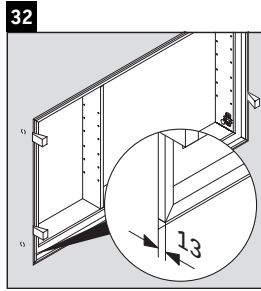
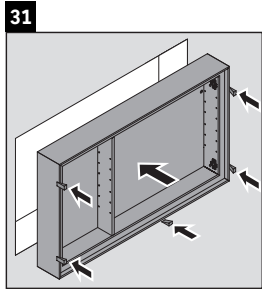
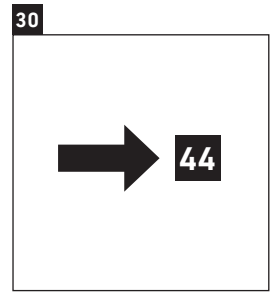
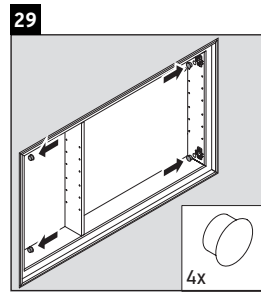
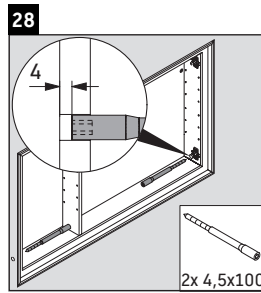
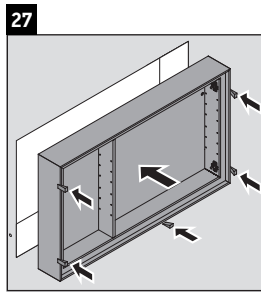
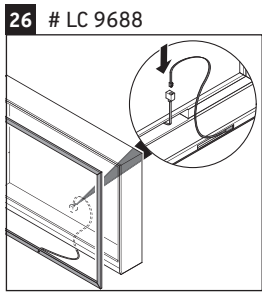

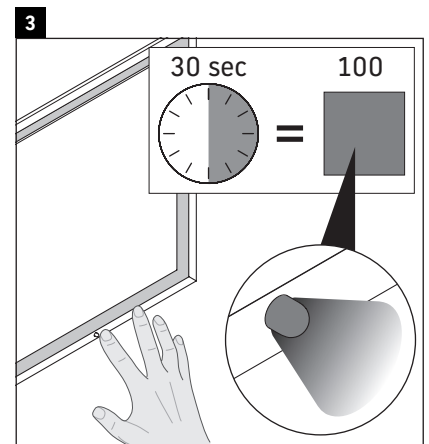
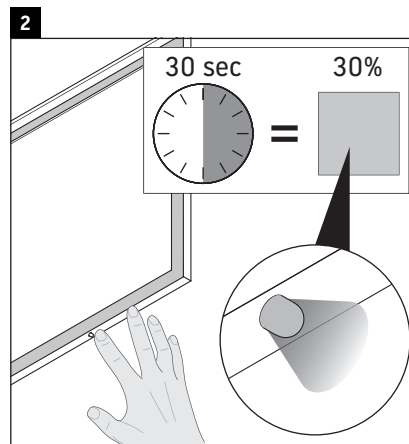
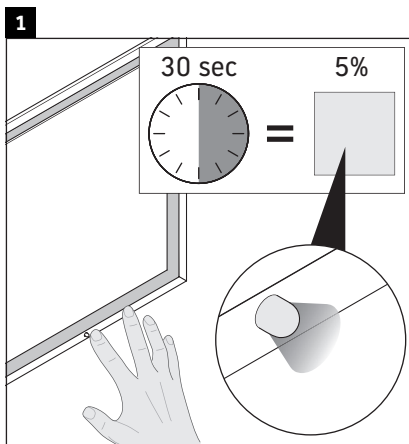
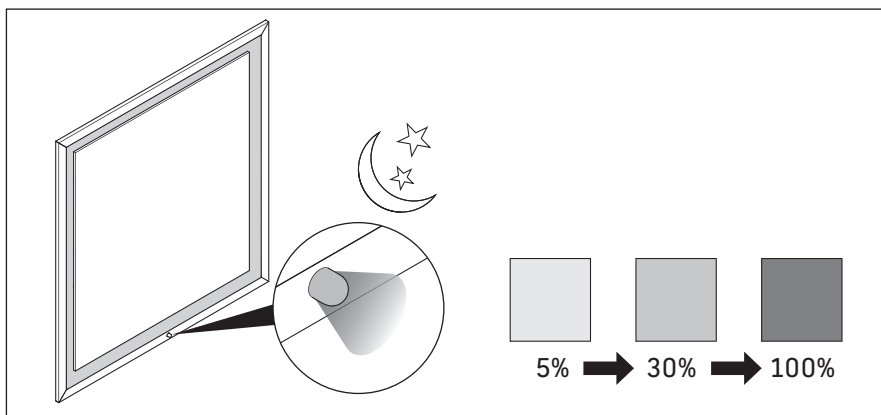
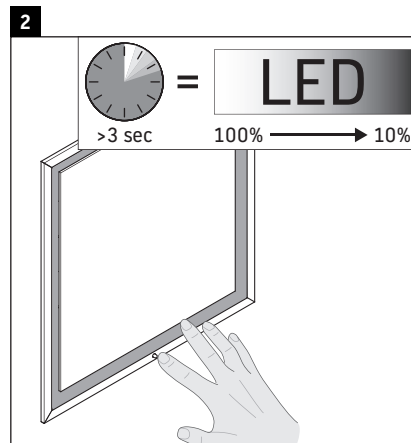
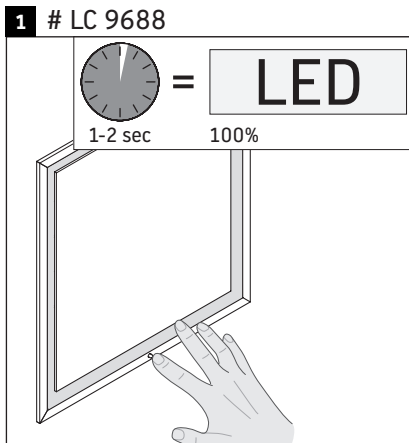

Istruzioni di montaggio per mobili da bagno con passaggio di corrente elettrica



Sicurezza

2



Installazione elettrica

3



Uso conforme

Le istruzioni di montaggio sono parte integrante del prodotto Duravit e si rivolgono a persone che realizzano l'installazione elettrica per il prodotto. Le istruzioni di montaggio devono essere lette con attenzione ed essere disponibili in qualsiasi momento.

Destinatari e competenza

L'installazione elettrica deve essere eseguita solo da elettricisti qualificati.

Tipo di protezione di prodotti Duravit

Il tipo di protezione di prodotti Duravit sotto tensione è conforme almeno allo standard IP 44.

Classi di protezione delle lampade

Classe di protezione	Linea di collegamento
I	H05VV-F, 3x 1,5 mm ²
II	H03VV-F, 2x 0,75 mm ²

Direttive e norme

I prodotti Duravit sono conformi alle direttive di marcatura CE:



Simboli

Simbolo	Significato
>	Operazione richiesta

Smaltimento

- Non smaltire il prodotto nei rifiuti domestici. Ai sensi della Direttiva RAEE i prodotti con questo simbolo devono essere consegnati a centri di raccolta pubblici per vecchie apparecchiature elettriche ed elettroniche per essere smaltiti.



Indicazioni di sicurezza

Pericolo di morte

Il contatto con la corrente provoca una scossa elettrica.

- > Realizzare l'installazione elettrica nel rispetto delle direttive e norme nazionali, europee e internazionali.
- > Rispettare le zone di protezione per ambienti umidi secondo le norme specifiche del Paese in questione, le disposizioni normative locali e le direttive per bassa tensione.
- > In ambienti umidi o in altri ambienti con caratteristiche particolari realizzare l'allacciamento elettrico con un interruttore magnetotermico GFI.
- > Prima dell'installazione scollegare i componenti elettrici dalla rete elettrica.
- > Controllare che tutti i componenti siano scollegati dalla tensione elettrica.
- > Evitare che l'alimentazione elettrica venga inserita accidentalmente.

Penetrazione di corpi estranei e acqua

La presenza di corpi estranei o acqua nell'apparecchiatura provoca un cortocircuito che può causare danni al prodotto.

- > Rispettare le zone di protezione per prodotti Duravit.

Zone di protezione

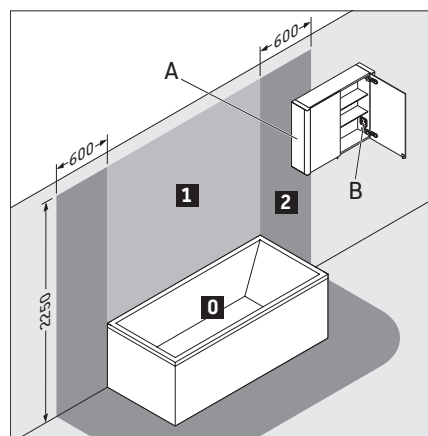

A L'armadietto a specchio con IP 44 può sporgere in zona 2.

B In presenza di una presa nell'armadietto a specchio, la presa deve essere montata al di fuori delle zone.

Classe di efficienza energetica

- Questo prodotto contiene una sorgente luminosa della classe di efficienza energetica F.



Installazione elettrica

Installazione elettrica per classe di protezione I

Allacciamento elettrico

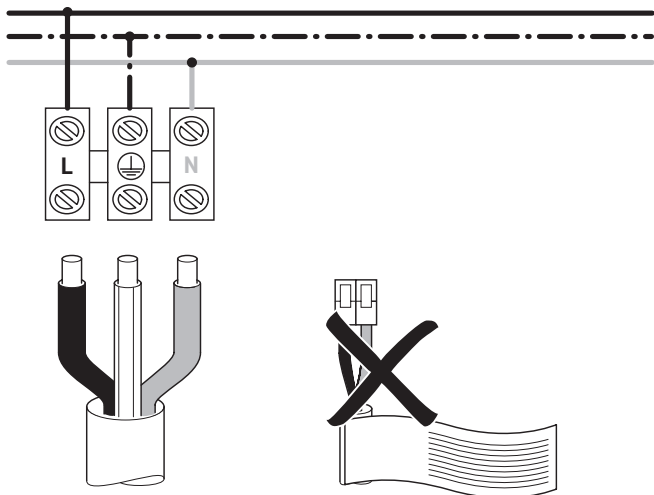

Kit opzionale di connessione di un tasto esterno

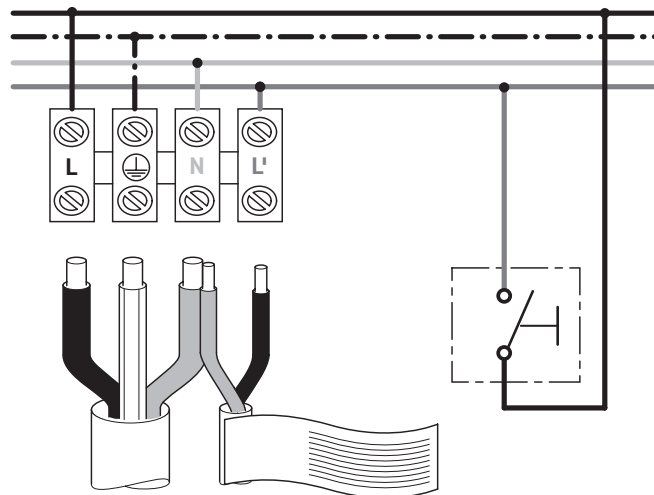

Installazione elettrica per classe di protezione II

Allacciamento elettrico

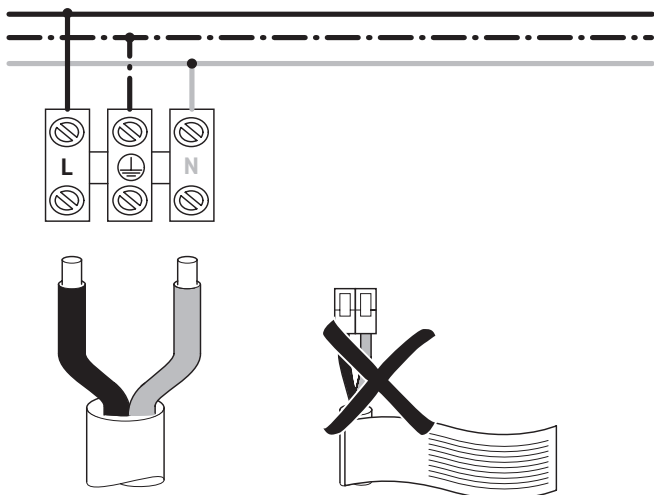

Kit opzionale di connessione di un tasto esterno

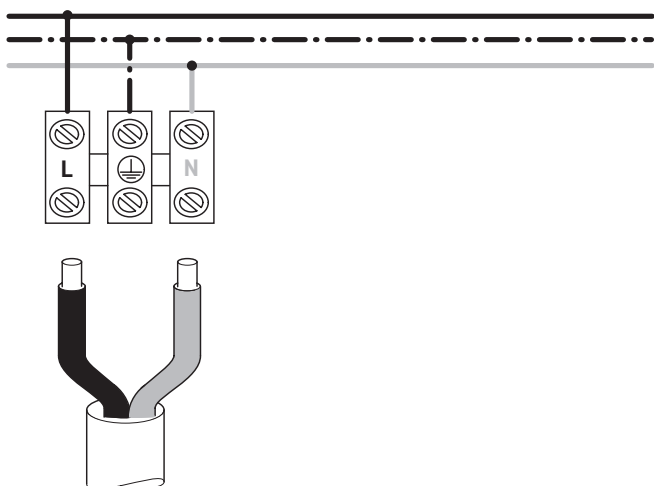
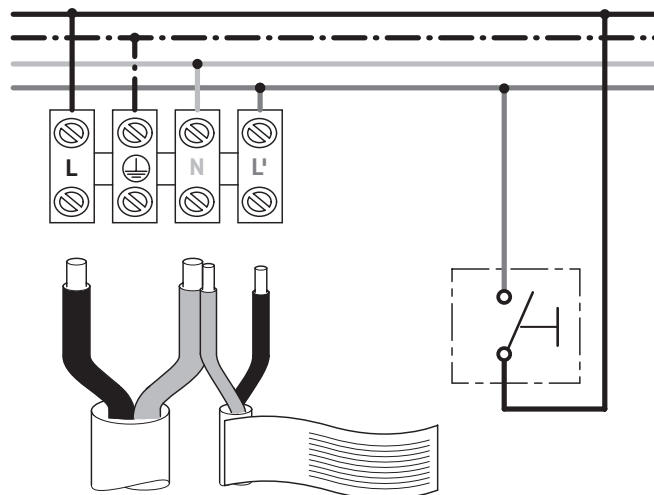

DURAVIT AG
P.O. Box 240
Werderstr. 36
78132 Hornberg
Germany
Phone +49 7833 70 0
Fax +49 7833 70 289
info@duravit.com
www.duravit.com

